

✓ A un nivel superior
A um nível superior

KTLL
L A D D E R S 

CATÁLOGO ANDAMIOS Y TORRES MÓVILES
CATÁLOGO DE ANDAIMES E TORRES MÓVEIS

2025/2026



✓ A un nivel superior
A um nível superior



Seguridad
Segurança



Garantía
Garantia

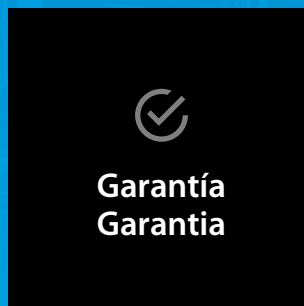

Sostenibilidad
Sustentabilidade



Diseño
Design

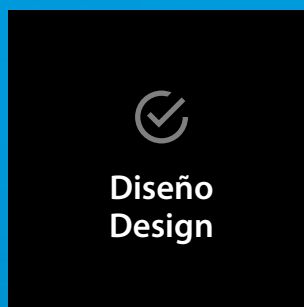

Calidad
Qualidade



ES En KTL-Ladders ofrecemos una amplia gama de andamios y torres de trabajo móviles de aluminio manteniendo los más elevados estándares de calidad certificada, mejorando la competitividad del producto y cumpliendo con los requisitos de seguridad de las respectivas Normas Europeas.

PT Na KTL-Ladders oferecemos uma vasta gama de andaimes e torres de trabalho móveis em alumínio, mantendo os mais elevados padrões de qualidade certificados, melhorando a competitividade do produto e cumprindo os requisitos de segurança das respectivas normas europeias.

04 | **Andamio-escalera plegable multiusos FAST 5**
Andaime de escada dobrável multiusos FAST 5

06 | **Andamio ES-3-O**
Andaime ES-3-O

07 | **Andamio plegable FLEXY**
Andaime dobrável FLEXY

08 | **Torre móvil profesional FAST ALTO**
Torre móvel profissional FAST ALTO

10 | **Torre móvil profesional K-TOWER S**
Torre móvel profissional K-TOWER S

12 | **K-TOWER S180**

14 | **K-TOWER S250**

16 | **K-TOWER S300**

18 | **Torre móvil profesional plegable K-TOWER F140**
Torre móvel profesional dobrável K-TOWER F140

FLEX
E
D
N
I



FAST 5 Andamio-escalera plegable multiusos
Andaime de escada dobrável multiusos

NFE 85-200

EN 131

150 kg



REF 20 255 178

143x51 cm



12'
min

Primer
Montaje

4'
min

Segundo
Montaje

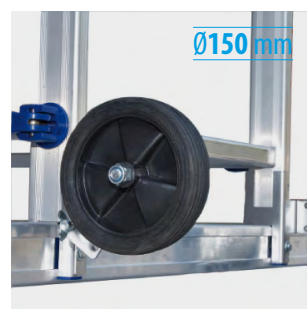

Ø150 mm

Ruedas de Ø150 mm con sistema de elevación
Rodas de Ø150 mm com sistema de elevação



60x24 mm

Articulaciones automáticas de fundición de aluminio
Juntas automáticas em alumínio fundido



**Lock
SYSTEM**

Montantes laterales con sistema FAST de posicionamiento
Montantes laterais com sistema de posicionamento FAST

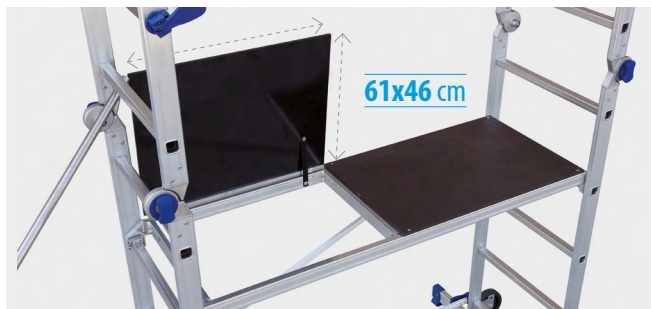

61x46 cm

Plataforma de trabajo de tablero fenólico antideslizante con trampilla
Plataforma de trabalho em placa fenólica antiderrapante com alçapão



Fácil desplazamiento
Movimiento fácil

REF												kg
20255 178	3,10	1,78	3,78	1,56	1,59	2,88	0,30	3,80	2,86	0,58	1,43 x 0,51	34,5

✂ DISPONEMOS DE UNA SELECCIÓN DE ACCESORIOS Y RECAMBIOS | SELEÇÃO DE ACESSÓRIOS E PEÇAS SOBRESALENTES DISPONÍVEIS



2 escaleras simples de apoyo
2 escadas de apoio simples



2 escaleras dobles
2 escadas duplas



Andamio para uso en interior
Andaímes para utilização em interiores

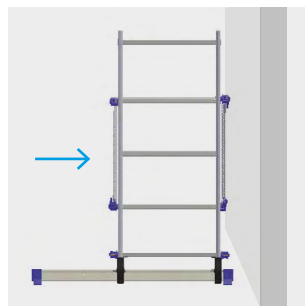

Base estabilizadora con doble posicionamiento
Base estabilizadora com duplo posicionamento



Sistema exclusivo de articulación hacia el exterior que permite no desmontar la parte baja del andamio
Sistema exclusivo de articulação para o exterior que permite que a parte inferior do andaime não seja desmontada

ES-3-0 Andamio
Andaime

2 PFG 1240/07.11

150 kg



REF 20 240 085



Rueda de Ø100 mm
Roda de Ø100 mm

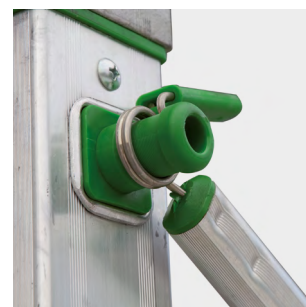

Bloqueo rápido de las diagonales con muelles en inox
Bloqueio rápido das travessas diagonais com molas em inox

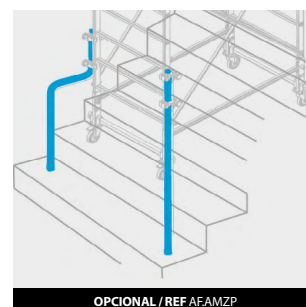

OPCIONAL / REF AFAMZP

Estabilizadores fijados con abrazaderas de aluminio
Estabilizadores fixados com grampos de alumínio

REF							kg
20 240 085	1,96	0,85	2,85	1,50	0,68	1,52 x 0,52	27,0

✂ DISPONEMOS DE UNA SELECCIÓN DE ACCESORIOS Y RECAMBIOS | SELEÇÃO DE ACESSÓRIOS E PEÇAS SOBRESSALENTES DISPONÍVEIS



12'
min
Primer
Montaje

6'
min
Segundo
Montaje

ANDAMIOS MÓVILES
ANDAIMES MÓVEIS

5 GARANTÍA
GARANTIA

FLEXY Andamio plegable
Andaime dobrável

2 PFG 1240/07.11

150 kg



REF 20 242 085



Bloqueo rápido de las diagonales con muelles en inox
Bloqueio rápido das travessas diagonais com molas em inox



Cierre basculante con fricción en nylon
Sistema de bloqueio por fricção em nylon

REF							kg
20 242 085	1,98	0,85	2,85	1,50	0,75	1,52 x 0,68	31,5

MONTAJE RÁPIDO

4' min Primer Montaje
2' min Segundo Montaje

✂️ DISPONEMOS DE UNA SELECCIÓN DE ACCESORIOS Y RECAMBIOS | SELEÇÃO DE ACESSÓRIOS E PEÇAS SOBRESSALENTES DISPONÍVEIS

FAST ALTO Torre móvil profesional
Torre móvel profissional

EN 1004-1-2 Clase 3

200 kg/m²

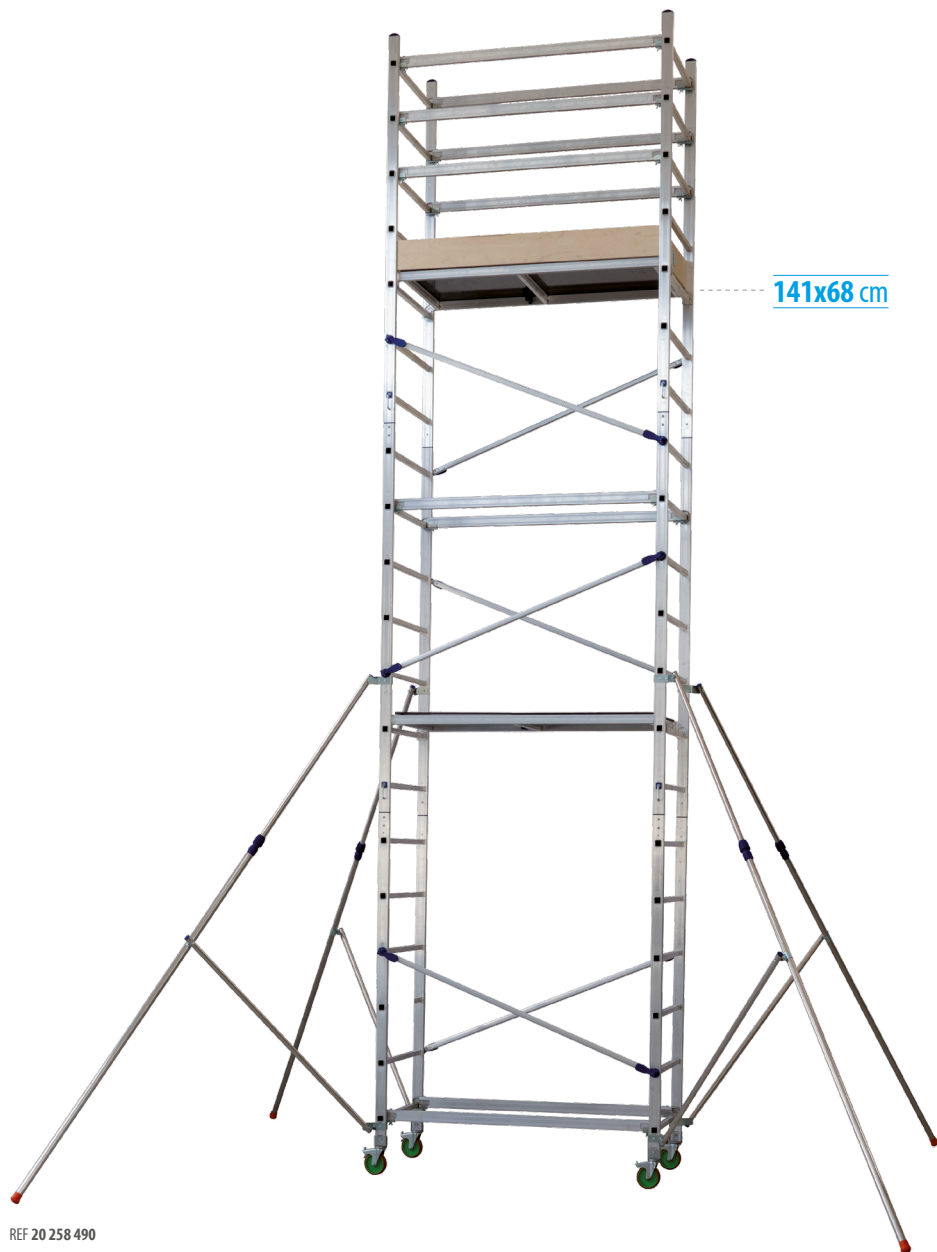

141x68 cm

REF 20 258 490



Enganches de seguridad en aluminio fundido
Fechos de segurança em alumínio fundido



Ø125 mm

Rueda de Ø125 mm
Roda de Ø125 mm

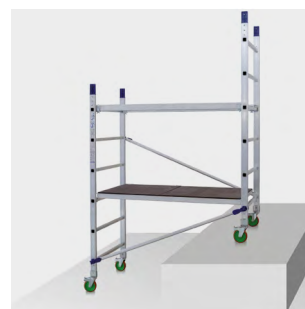

Lock
SYSTEM

Montantes laterales con sistema FAST de posicionamiento
Montantes laterais com sistema de posicionamento FAST



Tirantes rápidos antiapertura en acero
Braçadeiras de aço de libertação rápida anti-abertura



Zócalo plegable de una única pieza
Rodapé dobrável de uma só peça



Plataforma fenólica antideslizante con trampilla
Plataforma fenólica antiderrapante com alçapão



REF	Módulos Módulos							kg
20 256 100	A	2,05	1,00	3,00	1,55	0,75	1,41 x 0,68	27,0
20 257 280	A+B	4,10	2,80	4,80	1,55	0,75	1,41 x 0,68	62,0
20 258 490	A+B+C	6,20	4,90	6,90	1,55	0,75	1,41 x 0,68	86,0
20 256 200	B	-	-	-	-	-	1,41 x 0,68	35,0
20 256 300	C	-	-	-	-	-	1,41 x 0,68	24,0
20 266 100	P	2,05	1,00	3,00	1,55	0,75	1,41 x 0,68	31,0
20 267 280	P+B	4,10	2,80	4,80	1,55	0,75	1,41 x 0,68	66,0
20 268 490	P+B+C	6,20	4,90	6,90	1,55	0,75	1,41 x 0,68	90,0

✂ DISPONEMOS DE UNA SELECCIÓN DE ACCESORIOS Y RECAMBIOS | SELEÇÃO DE ACESSÓRIOS E PEÇAS SOBRESSALENTES DISPONÍVEIS

CONFIGURACIONES | CONFIGURAÇÕES

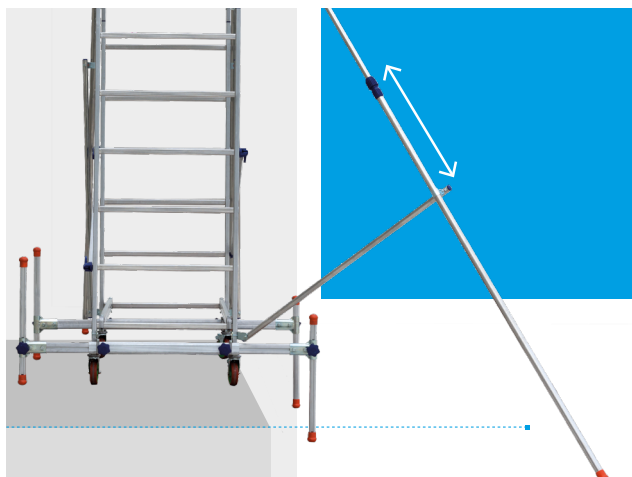
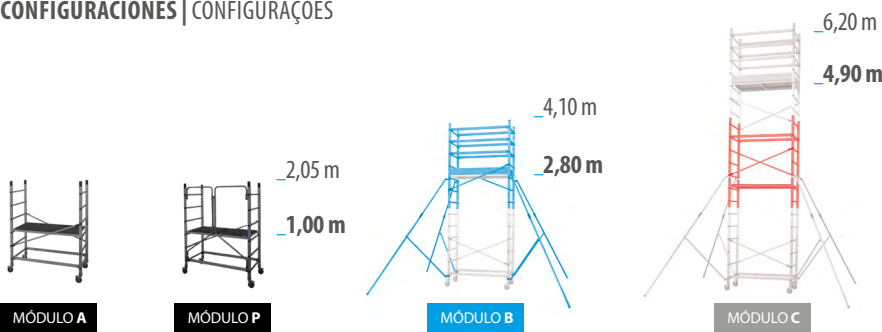

Estabilizador telescópico
Estabilizador telescópico



Niveladores regulables horizontal y verticalmente
Niveladores ajustáveis horizontal e verticalmente



Módulo base plegable (P) para un fácil transporte
Módulo de base dobrável (P) para facilitar o transporte

K-TOWER S Torre móvil profesional
Torre móvel profissional

EN 1004-1-2 Clase 3

200 kg/m²

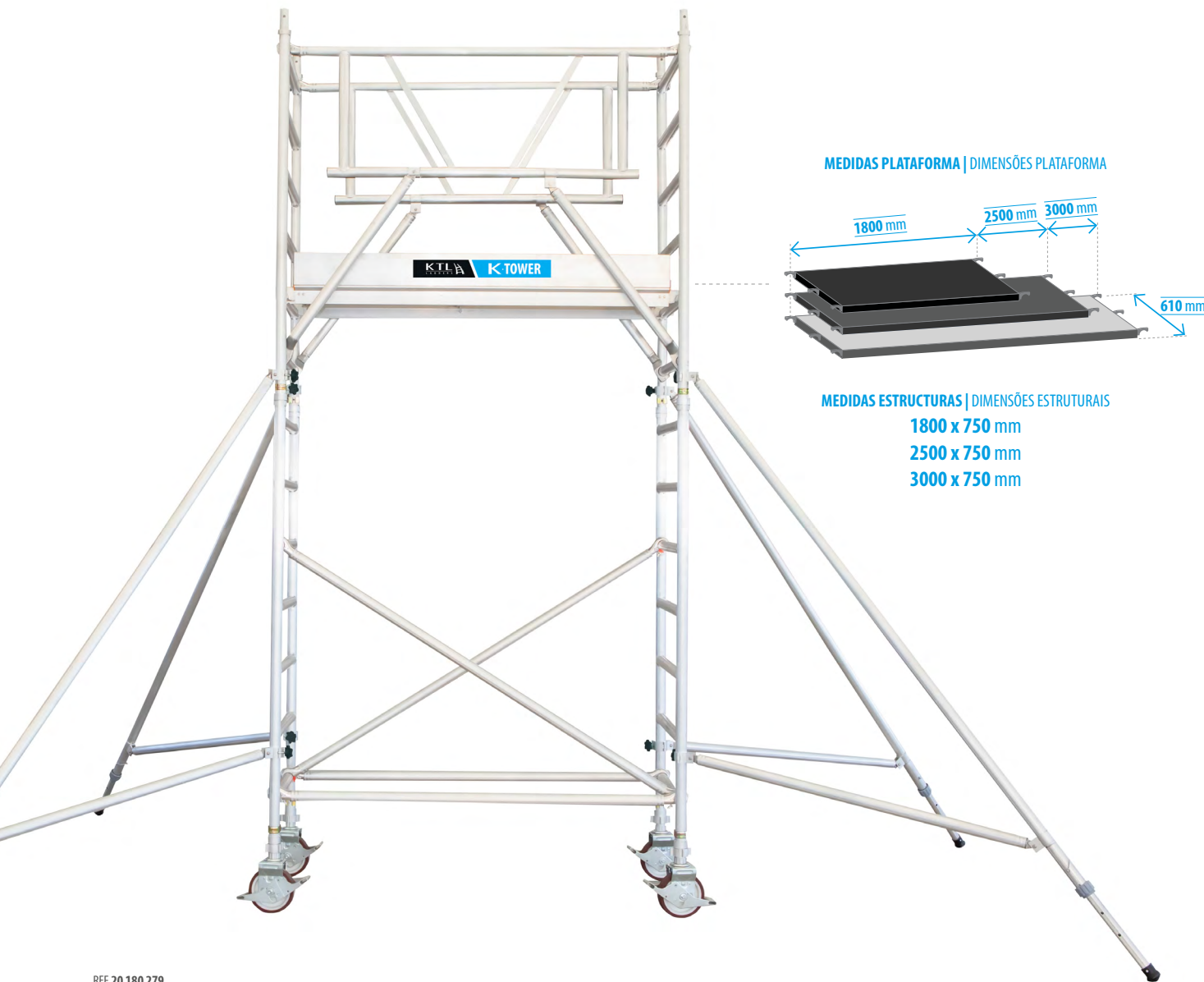

REF 20 180 279



Rueda de Ø200 mm con freno, regulable en altura
Roda de Ø200 mm com travão, regulável em altura



Enganches de seguridad en aluminio fundido
Fechos de segurança em alumínio fundido



Plataforma fenólica antideslizante con trampilla
Plataforma fenólica antiderrapante com alçapão

ES Máxima seguridad, estabilidad y resistencia durante el uso.







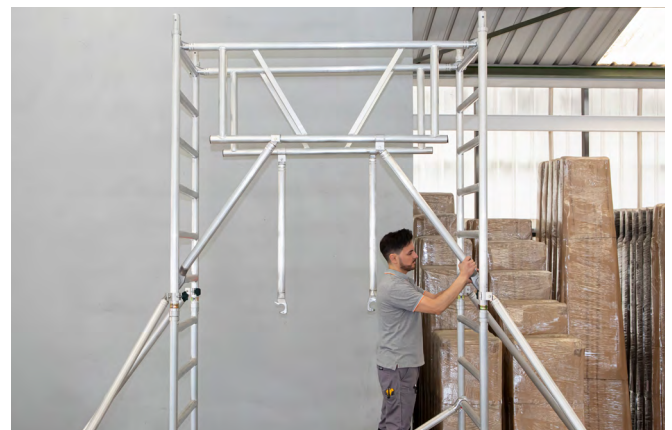
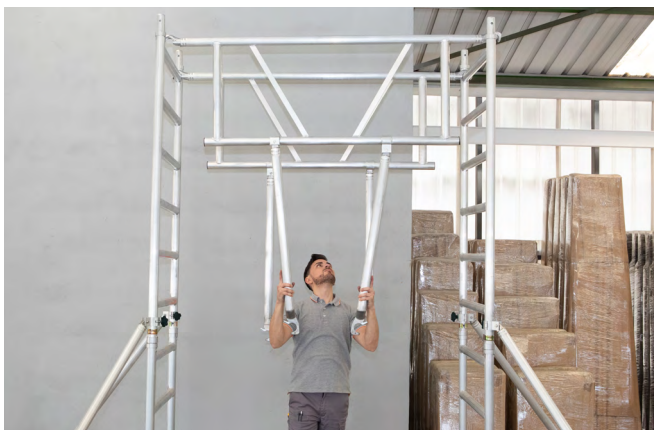

Barandilla de seguridad SAS diseñada para montaje y desmontaje seguro desde plataformas inferiores.

PT Máxima segurança, estabilidade e resistência durante a utilização.

Corrimão de segurança SAS, concebido para uma montagem e desmontagem seguras a partir de plataformas inferiores.

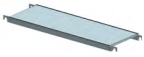

K-TOWER S180

REF	  			kg	     					
	KT00M7	KT01M6	KT02M5		KT03M4	KT80PAG180	KT10PT18061			
20 180 111	1,11	2,11	3,11	65,17	2				2	1
20 180 139	1,39	2,39	3,39	68,12				4	2	1
20 180 167	1,67	2,67	3,67	69,92			2	2	2	1
20 180 195	1,95	2,95	3,95	76,12		2		2	2	1
20 180 223	2,23	3,23	4,23	83,76	2			2	2	1
20 180 251	2,51	3,51	4,51	103,00	2		2		2	1
20 180 279	2,79	3,79	4,79	104,72	2	2			2	1
20 180 307	3,07	4,07	5,07	106,40	4				2	1
20 180 335	3,35	4,35	5,35	113,82	2			4	2	1
20 180 363	3,63	4,63	5,63	132,56	2		2	2	4	2
20 180 391	3,91	4,91	5,91	138,76	2	2		2	4	2
20 180 419	4,19	5,19	6,19	140,44	4			2	4	2
20 180 447	4,47	5,47	6,47	142,43	2	4			4	2
20 180 475	4,75	5,75	6,75	144,11	4	2			4	2
20 180 503	5,03	6,03	7,03	145,79	6				4	2
20 180 531	5,31	6,31	7,31	153,27	2		6		4	2
20 180 559	5,59	6,59	7,59	154,87	4		2	2	4	2
20 180 587	5,87	6,87	7,87	178,01	4	2		2	6	3
20 180 615	6,15	7,15	8,15	179,69	6			2	6	3
20 180 643	6,43	7,43	8,43	181,64	6		2		6	3
20 180 671	6,71	7,71	8,71	183,36	6	2			6	3
20 180 699	6,99	7,99	8,99	185,04	8				6	3
20 180 727	7,27	8,27	9,27	191,12	6			4	6	3
20 180 755	7,55	8,55	9,55	193,12		10			6	3
20 180 783	7,83	8,83	9,83	199,12	6	2		2	6	3
20 180 811	8,11	9,11	10,11	222,22	8			2	8	4
20 180 839	8,39	9,39	10,39	224,06	6	4			8	4
20 180 867	8,67	9,67	10,67	225,89	8	2			8	4
20 180 895	8,95	9,95	10,95	227,57	10				8	4
20 180 923	9,23	10,23	11,23	230,37	8			4	8	4
20 180 951	9,51	10,51	11,51	232,17	8		2	2	8	4
20 180 979	9,79	10,79	11,79	233,97	8		4		8	4
20 181 007	10,07	11,07	12,07	240,05	10			2	8	4
20 181 035	10,35	11,35	12,35	263,42	10		2		10	5
20 181 063	10,63	11,63	12,63	265,14	10	2			10	5
20 181 091	10,91	11,91	12,91	266,82	12				10	5
20 181 119	11,19	12,19	13,19	269,62	10			4	10	5
20 181 147	11,47	12,47	13,47	271,42	10		2	2	10	5
20 181 175	11,75	12,75	13,75	277,62	10	2		2	10	5









ES **IMPORTANTE:** Algunas configuraciones deben utilizar contrapesos, como se indica en el manual de instrucciones adjunto a la torre móvil.



							REF
KT20Z018061	KT30HR180	KT35DG212	KT50RU200	KT75CLIP	KT60ESA200	KT65ESA260	
	2		4	4			20 180 111
	2		4	8			20 180 139
	2		4	8			20 180 167
	2	2	4	8			20 180 195
1	2	2	4	8			20 180 223
1	2	2	4	8	4		20 180 251
1	2	2	4	8	4		20 180 279
1	2	2	4	8	4		20 180 307
1	2	4	4	12	4		20 180 335
1	2		4	12	4		20 180 363
1	2	2	4	12	4		20 180 391
1	2	2	4	12	4		20 180 419
1	2	2	4	16	4		20 180 447
1	2	2	4	16	4		20 180 475
1	2	2	4	16	4		20 180 503
1	2	4	4	16	4		20 180 531
1	2	4	4	16	4		20 180 559
1	2	2	4	16	4		20 180 587
1	2	2	4	16	4		20 180 615
1	2	2	4	20	4		20 180 643
1	2	2	4	20	4		20 180 671
1	2	2	4	20	4		20 180 699
1	2	2	4	20		4	20 180 727
1	2	2	4	20		4	20 180 755
1	2	4	4	20		4	20 180 783
1	2	2	4	20		4	20 180 811
1	2	2	4	20		4	20 180 839
1	2	2	4	24		4	20 180 867
1	2	2	4	24		4	20 180 895
1	2	2	4	24		4	20 180 923
1	2	2	4	24		4	20 180 951
1	2	2	4	24		4	20 180 979
1	2	4	4	24		4	20 181 007
1	2	2	4	28		4	20 181 035
1	2	2	4	28		4	20 181 063
1	2	2	4	28		4	20 181 091
1	2	2	4	28		4	20 181 119
1	2	2	4	28		4	20 181 147
1	2	4	4	28		4	20 181 175

PT **IMPORTANTE:** Algumas configurações têm de utilizar contrapesos, conforme indicado no manual de instruções fornecido com a torre móvel.

K-TOWER S250

REF	  			kg	     						
	KT00M7	KT01M6	KT02M5		KT03M4	KT85PAG250	KT11PT25061				
20 250 111	1,11	2,11	3,11	73,25	2					2	1
20 250 139	1,39	2,39	3,39	76,20				4		2	1
20 250 167	1,67	2,67	3,67	78,00			2	2		2	1
20 250 195	1,95	2,95	3,95	85,04		2		2		2	1
20 250 223	2,23	3,23	4,23	94,38	2			2		2	1
20 250 251	2,51	3,51	4,51	113,62	2		2			2	1
20 250 279	2,79	3,79	4,79	115,34	2	2				2	1
20 250 307	3,07	4,07	5,07	117,02	4					2	1
20 250 335	3,35	4,35	5,35	125,28	2			4		2	1
20 250 363	3,63	4,63	5,63	149,38	2		2	2		4	2
20 250 391	3,91	4,91	5,91	156,42	2	2		2		4	2
20 250 419	4,19	5,19	6,19	158,10	4			2		4	2
20 250 447	4,47	5,47	6,47	160,09	2	4				4	2
20 250 475	4,75	5,75	6,75	161,77	4	2				4	2
20 250 503	5,03	6,03	7,03	163,45	6					4	2
20 250 531	5,31	6,31	7,31	171,77	2		6			4	2
20 250 559	5,59	6,59	7,59	173,37	4		2	2		4	2
20 250 587	5,87	6,87	7,87	202,71	4	2		2		6	3
20 250 615	6,15	7,15	8,15	204,39	6			2		6	3
20 250 643	6,43	7,43	8,43	206,34	6		2			6	3
20 250 671	6,71	7,71	8,71	208,06	6	2				6	3
20 250 699	6,99	7,99	8,99	209,74	8					6	3
20 250 727	7,27	8,27	9,27	215,82	6			4		6	3
20 250 755	7,55	8,55	9,55	217,82		10				6	3
20 250 783	7,83	8,83	9,83	224,66	6	2		2		6	3
20 250 811	8,11	9,11	10,11	253,96	8			2		8	4
20 250 839	8,39	9,39	10,39	255,80	6	4				8	4
20 250 867	8,67	9,67	10,67	257,63	8	2				8	4
20 250 895	8,95	9,95	10,95	259,31	10					8	4
20 250 923	9,23	10,23	11,23	262,11	8			4		8	4
20 250 951	9,51	10,51	11,51	263,91	8		2	2		8	4
20 250 979	9,79	10,79	11,79	265,71	8		4			8	4
20 251 007	10,07	11,07	12,07	272,63	10			2		8	4
20 251 035	10,35	11,35	12,35	302,20	10		2			10	5
20 251 063	10,63	11,63	12,63	303,92	10	2				10	5
20 251 091	10,91	11,91	12,91	305,60	12					10	5
20 251 119	11,19	12,19	13,19	308,40	10			4		10	5
20 251 147	11,47	12,47	13,47	310,20	10		2	2		10	5
20 251 175	11,75	12,75	13,75	317,24	10	2		2		10	5









ES **IMPORTANTE:** Algunas configuraciones deben utilizar contrapesos, como se indica en el manual de instrucciones adjunto a la torre móvil.



							REF
KT21Z025061	KT31HR250	KT36DG274	KT50RU200	KT75CLIP	KT60ESA200	KT65ESA260	
	2		4	4			20 250 111
	2		4	8			20 250 139
	2		4	8			20 250 167
	2	2	4	8			20 250 195
1	2	2	4	8			20 250 223
1	2	2	4	8	4		20 250 251
1	2	2	4	8	4		20 250 279
1	2	2	4	8	4		20 250 307
1	2	4	4	12	4		20 250 335
1	2		4	12	4		20 250 363
1	2	2	4	12	4		20 250 391
1	2	2	4	12	4		20 250 419
1	2	2	4	16	4		20 250 447
1	2	2	4	16	4		20 250 475
1	2	2	4	16	4		20 250 503
1	2	4	4	16	4		20 250 531
1	2	4	4	16	4		20 250 559
1	2	2	4	16	4		20 250 587
1	2	2	4	16	4		20 250 615
1	2	2	4	20	4		20 250 643
1	2	2	4	20	4		20 250 671
1	2	2	4	20	4		20 250 699
1	2	2	4	20		4	20 250 727
1	2	2	4	20		4	20 250 755
1	2	4	4	20		4	20 250 783
1	2	2	4	20		4	20 250 811
1	2	2	4	20		4	20 250 839
1	2	2	4	24		4	20 250 867
1	2	2	4	24		4	20 250 895
1	2	2	4	24		4	20 250 923
1	2	2	4	24		4	20 250 951
1	2	2	4	24		4	20 250 979
1	2	4	4	24		4	20 251 007
1	2	2	4	28		4	20 251 035
1	2	2	4	28		4	20 251 063
1	2	2	4	28		4	20 251 091
1	2	2	4	28		4	20 251 119
1	2	2	4	28		4	20 251 147
1	2	4	4	28		4	20 251 175

PT **IMPORTANTE:** Algumas configurações têm de utilizar contrapesos, conforme indicado no manual de instruções fornecido com a torre móvel.

K-TOWER S300

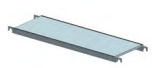
REF	  			kg	     					
	KT00M7	KT01M6	KT02M5		KT03M4	KT90PAG300	KT12PT30061			
20 300 111	1,11	2,11	3,11	79,51	2				2	1
20 300 139	1,39	2,39	3,39	82,46				4	2	1
20 300 167	1,67	2,67	3,67	84,26			2	2	2	1
20 300 195	1,95	2,95	3,95	91,94		2		2	2	1
20 300 223	2,23	3,23	4,23	102,36	2			2	2	1
20 300 251	2,51	3,51	4,51	121,60	2		2		2	1
20 300 279	2,79	3,79	4,79	123,32	2	2			2	1
20 300 307	3,07	4,07	5,07	125,00	4				2	1
20 300 335	3,35	4,35	5,35	133,90	2			4	2	1
20 300 363	3,63	4,63	5,63	162,34	2		2	2	4	2
20 300 391	3,91	4,91	5,91	170,02	2	2		2	4	2
20 300 419	4,19	5,19	6,19	171,70	4			2	4	2
20 300 447	4,47	5,47	6,47	173,69	2	4			4	2
20 300 475	4,75	5,75	6,75	175,37	4	2			4	2
20 300 503	5,03	6,03	7,03	177,05	6				4	2
20 300 531	5,31	6,31	7,31	186,01	2		6		4	2
20 300 559	5,59	6,59	7,59	187,61	4		2	2	4	2
20 300 587	5,87	6,87	7,87	221,93	4	2		2	6	3
20 300 615	6,15	7,15	8,15	223,61	6			2	6	3
20 300 643	6,43	7,43	8,43	225,56	6		2		6	3
20 300 671	6,71	7,71	8,71	227,28	6	2			6	3
20 300 699	6,99	7,99	8,99	228,96	8				6	3
20 300 727	7,27	8,27	9,27	235,04	6			4	6	3
20 300 755	7,55	8,55	9,55	237,04		10			6	3
20 300 783	7,83	8,83	9,83	244,52	6	2		2	6	3
20 300 811	8,11	9,11	10,11	278,80	8			2	8	4
20 300 839	8,39	9,39	10,39	280,64	6	4			8	4
20 300 867	8,67	9,67	10,67	282,47	8	2			8	4
20 300 895	8,95	9,95	10,95	284,15	10				8	4
20 300 923	9,23	10,23	11,23	286,95	8			4	8	4
20 300 951	9,51	10,51	11,51	288,75	8		2	2	8	4
20 300 979	9,79	10,79	11,79	290,55	8		4		8	4
20 301 007	10,07	11,07	12,07	298,11	10			2	8	4
20 301 035	10,35	11,35	12,35	332,66	10		2		10	5
20 301 063	10,63	11,63	12,63	334,38	10	2			10	5
20 301 091	10,91	11,91	12,91	336,06	12				10	5
20 301 119	11,19	12,19	13,19	338,86	10			4	10	5
20 301 147	11,47	12,47	13,47	340,66	10		2	2	10	5
20 301 175	11,75	12,75	13,75	348,34	10	2		2	10	5

ES **IMPORTANTE:** Algunas configuraciones deben utilizar contrapesos, como se indica en el manual de instrucciones adjunto a la torre móvil.



	KT22Z030061	KT32HR300	KT37DG320	KT50RU200	KT75CLIP	KT60ESA200	KT65ESA260	REF
		2		4	4			20 300 111
		2		4	8			20 300 139
		2		4	8			20 300 167
		2	2	4	8			20 300 195
1		2	2	4	8			20 300 223
1		2	2	4	8	4		20 300 251
1		2	2	4	8	4		20 300 279
1		2	2	4	8	4		20 300 307
1		2	4	4	12	4		20 300 335
1		2		4	12	4		20 300 363
1		2	2	4	12	4		20 300 391
1		2	2	4	12	4		20 300 419
1		2	2	4	16	4		20 300 447
1		2	2	4	16	4		20 300 475
1		2	2	4	16	4		20 300 503
1		2	4	4	16	4		20 300 531
1		2	4	4	16	4		20 300 559
1		2	2	4	16	4		20 300 587
1		2	2	4	16	4		20 300 615
1		2	2	4	20	4		20 300 643
1		2	2	4	20	4		20 300 671
1		2	2	4	20	4		20 300 699
1		2	2	4	20		4	20 300 727
1		2	2	4	20		4	20 300 755
1		2	4	4	20		4	20 300 783
1		2	2	4	20		4	20 300 811
1		2	2	4	20		4	20 300 839
1		2	2	4	24		4	20 300 867
1		2	2	4	24		4	20 300 895
1		2	2	4	24		4	20 300 923
1		2	2	4	24		4	20 300 951
1		2	2	4	24		4	20 300 979
1		2	4	4	24		4	20 301 007
1		2	2	4	28		4	20 301 035
1		2	2	4	28		4	20 301 063
1		2	2	4	28		4	20 301 091
1		2	2	4	28		4	20 301 119
1		2	2	4	28		4	20 301 147
1		2	4	4	28		4	20 301 175

PT **IMPORTANTE:** Algumas configurações têm de utilizar contrapesos, conforme indicado no manual de instruções fornecido com a torre móvel.

K-TOWER F140 Torre móvil profesional plegable
Torre móvel profissional dobrável

EN 1004-1-2 Clase 3

200 kg/m²



MEDIDA PLATAFORMA | DIMENSÃO PLATAFORMA
1400 x 600 mm

MEDIDA ESTRUCTURA | DIMENSÃO ESTRUTURA
1400 x 750 mm

REF 20 140 320



Rueda de Ø150 mm con freno
Roda de Ø150 mm com travão



Enganches de seguridad en aluminio fundido
Fechos de segurança em alumínio fundido



Plataforma fenólica antideslizante con trampilla
Plataforma fenólica antiderrapante com alçapão

ES Ideal para trabajos rápidos o desplazamientos frecuentes dentro de la obra o de instalaciones.

El diseño de base plegable permite un montaje y desmontaje rápido, además de un ahorro de espacio en transporte y en almacenamiento.

PT Ideal para trabalhos rápidos ou movimentos frequentes no local de construção ou nas instalações.

O design da base dobrável permite uma montagem e desmontagem rápidas, bem como um transporte e armazenamento que poupam espaço.



K-TOWER F140

REF				kg					
	KT06MF	KT03M4	KT02M5		KT01M6	KT05GF			
20 140 096	0,96	1,96	2,96	37,65	1				
20 140 180	1,80	2,80	3,80	48,92	1	2			
20 140 292	2,92	3,92	4,92	78,04	1	4			
20 140 320	3,20	4,20	5,20	79,84	1	2	2		
20 140 348	3,48	4,48	5,48	81,56	1	2		2	
20 140 404	4,04	5,04	6,04	102,79	1	6			
20 140 432	4,32	5,32	6,32	106,15	1	4	2		
20 140 460	4,60	5,60	6,60	107,87	1	4		2	
20 140 488	4,88	5,88	6,88	113,15	1	2	2	2	
20 140 516	5,16	6,16	7,16	114,87	1	2		4	



OPCIONAL

Barandilla plegable | Corrimão dobrável

REF KT05GF





REF

KT25Z014060	KT15PT14060	KT40HR140	KT45DG163	KT70ESF180	KT55RU125	KT75CLIP	REF
1	1	2			4	4	20 140 096
1	1	4			4	8	20 140 180
1	1	6	3	4	4	12	20 140 292
1	1	6	3	4	4	12	20 140 320
1	1	6	3	4	4	12	20 140 348
1	2	8	5	4	4	16	20 140 404
1	2	9	5	4	4	16	20 140 432
1	2	9	5	4	4	16	20 140 460
1	2	9	7	4	4	16	20 140 488
1	2	9	7	4	4	16	20 140 516



ES Las imágenes incluidas en esta publicación son propiedad de KTL LADDERS, S.L.U.

Su reproducción total o parcial, así como su uso sin el consentimiento expreso del propietario, no están permitidos, quedando suscritos a aprobación contractual por las partes.

KTL LADDERS, S.L.U. se reserva el derecho de modificar, total o parcialmente, así como de realizar cambios en sus sistemas productivos, selección de materias primas y materiales, acabados, etc., que considere necesarios para la mejora de sus productos y su adecuación a los cambios normativos aplicables.

PT As imagens incluídas nesta publicação são propriedade de KTL LADDERS, S.L.U.

A sua reprodução total ou parcial, bem como a sua utilização sem o consentimento expreso do proprietário, não são permitidas, sendo assinada a aprovação contratual pelas partes.

KTL LADDERS, S.L.U. reserva-se o direito de modificar, total ou parcialmente, bem como fazer alterações em seus sistemas de produção, seleção de matérias-primas e materiais, acabamentos, etc., que julgar necessário para a melhoria dos seus produtos e a sua adaptação às mudanças regulatórias aplicáveis.



Amplia gama de productos
Amplia gama de productos



CATÁLOGO ANDAMIOS Y TORRES MÓVILES
CATÁLOGO DE ANDAIMES E TORRES MÓVEIS

2025/2026



✓ A un nivel superior
A um nível superior



Cno. Vell de Liria · Pol. Industrial
Los Vientos · 46119 Náquera
Valencia · España
Tel. +34 96 169 81 50
comercial@ktl-escaleras.es

www.ktl-escaleras.es